

ISOMETRIC VIEW

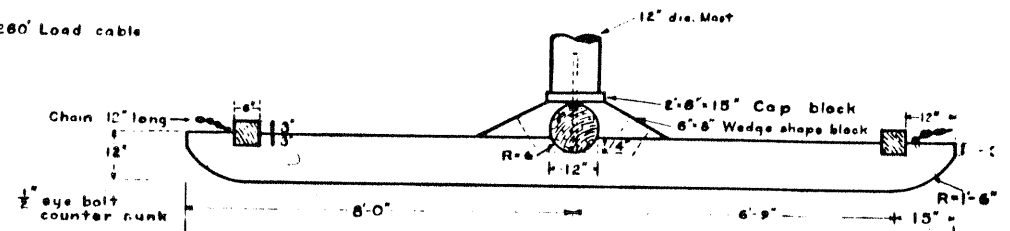

Side View

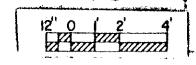
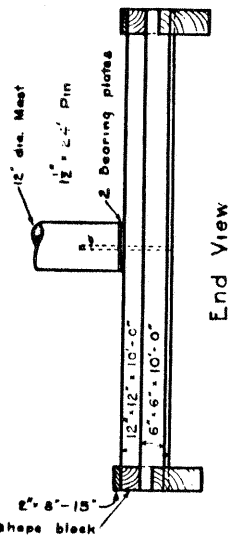

End View

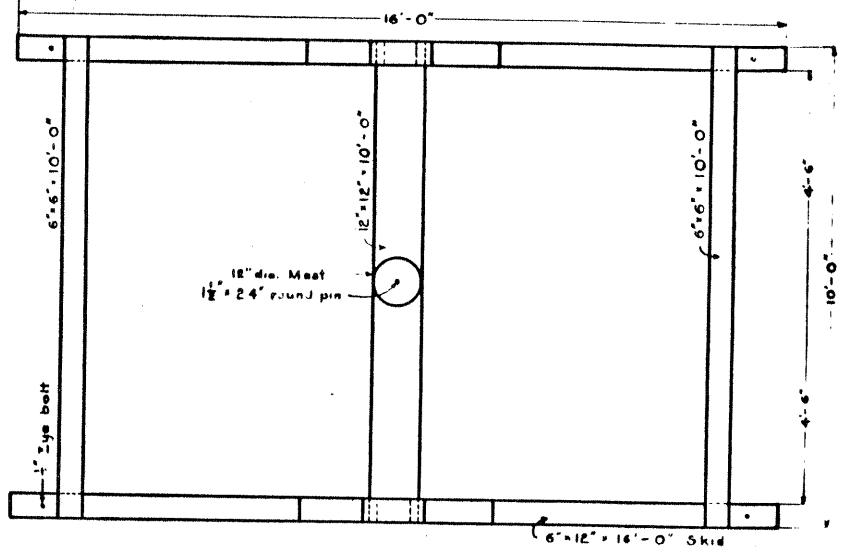

Plan

SLED

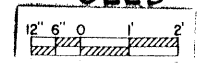

COOPERATIVE EXTENSION WORK IN
 AGRICULTURE AND HOME ECONOMICS

AND
 U. S. DEPT. OF AGRICULTURE COOPERATING

HAY STACKER

CALIF. EX 5523 SHEET 1 OF 2

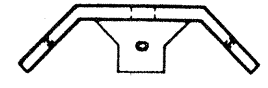
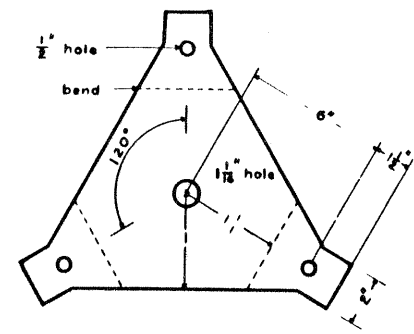
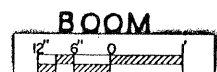
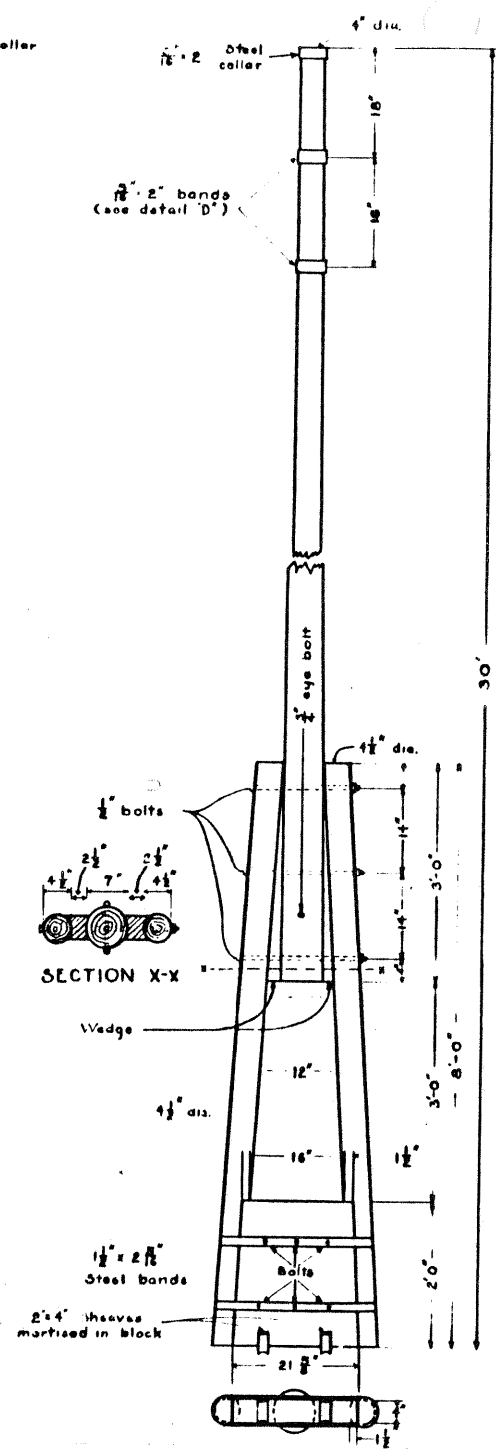
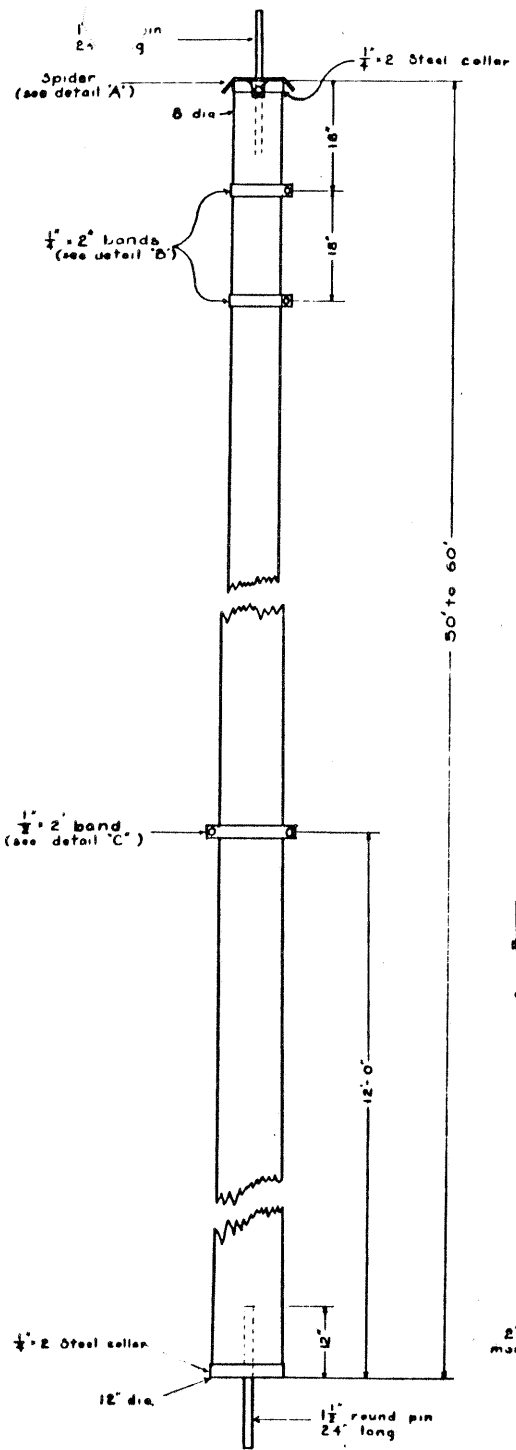

DETAIL 'A' SPIDER
To be made of 1/2" plate (W.I.) (1 required)

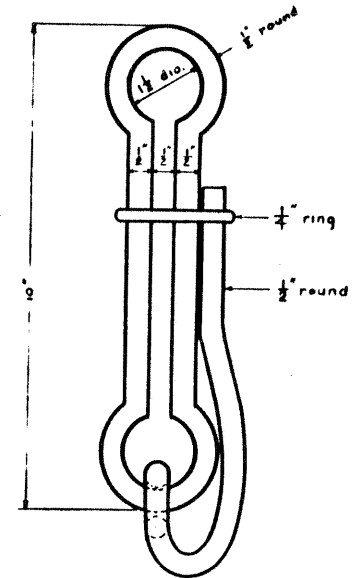

TOGCEL

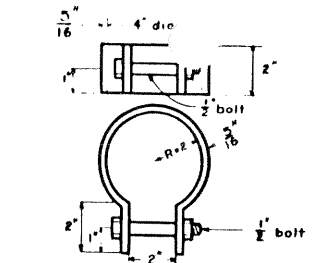

DETAIL 'D' BANDS
(2 Required)

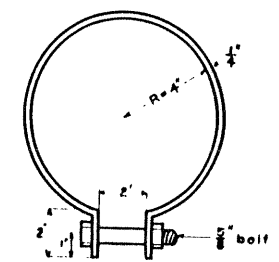
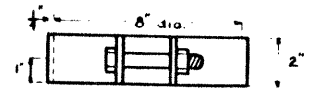

DETAIL 'B' BANDS
2 Required

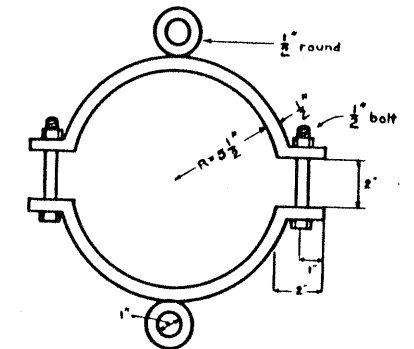

DETAIL 'C' GUY BAND
(1 Required)